



SENTRY
SHADING

Expertly Crafted Shading Solutions.

PRODUCT GUIDE

WWW.SENTRYSHADING.COM



PROUDLY MANUFACTURED IN CANADA

03	Our Promise
04	The Collection
06	Fabrics
07	Hem Bars
08	Colour Studio
10	Ceiling Pockets
12	Innovation
18	Project Showcase
31	Architect Resources



CONTENTS

OUR PROMISE

Engineered for Impact. Designed for Simplicity.

Sentry Shading redefines what you should expect from a commercial shading manufacturer. Precision engineering, adaptable systems, and uncompromising execution: this is the standard we're setting for the industry.

Window coverings are critical building infrastructure. They shape how spaces perform, how occupants experience light, and how buildings manage energy. We manufacture shading systems that integrate seamlessly with your design and deliver the clean, refined aesthetic your projects demand.

Quality, speed, reliability. Every project, every time. That's the Sentry standard.

WHY CHOOSE SENTRY SHADING

Precision & Quality Control

Every Sentry Shade is crafted with meticulous attention to detail, ensuring consistent performance and reliable quality you can trust.

Customization & Flexibility

We craft shading solutions tailored to your exact needs, from custom dimensions and specialized features to precise finishes. The result is a perfect fit for your project, every time.

Faster Lead Times & Cost Efficiency

Our streamlined production process eliminates delays and reduces costs, giving you exceptional value without compromise.

Canadian Made Excellence

Made in Canada using advanced manufacturing and industry-leading expertise, our products deliver durability, innovation, and long-term performance.

MANUAL OPTIONS

CHAIN OPERATED

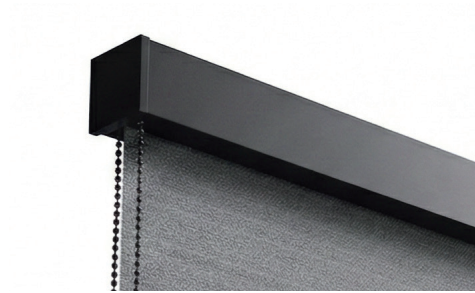

Manual Chain Operated - 4" Cassette
SS-RS-MAN-CH-CS4



Manual Chain Operated - Open Roll
SS-RS-MAN-CH-OR



Manual Chain Operated - 3" Fascia
SS-RS-MAN-CH-FA3



Manual Chain Operated - 4" Fascia
SS-RS-MAN-CH-FA4

CORDLESS



Manual Cordless - 4" Cassette
SS-RS-MAN-CL-CS4



Manual Cordless - Open Roll
SS-RS-MAN-CL-OR



Manual Cordless - 3" Fascia
SS-RS-MAN-CL-FA3



Manual Cordless - 4" Fascia
SS-RS-MAN-CL-FA4

MOTORIZED OPTIONS

HARD WIRED

Hard Wired motorization integrates directly into building electrical systems for permanent, reliable power.

Consistent performance with zero battery maintenance. Professional installation ensures seamless operation and compatibility with building automation. Ideal for new construction and large scale projects where power access is available.

Products

- Motorized Hard Wired - 4" Cassette- [SS-RS-MOT-HW-CS4](#)
- Motorized Hard Wired - 4" Fascia- [SS-RS-MOT-HW-FA4](#)
- Motorized Hard Wired - Open Roll- [SS-RS-MOT-HW-OR](#)
- Motorized Hard Wired - 3" Fascia - [SS-RS-MOT-HW-FA3](#)



Permanent
power



Zero
Maintenance



Automation
Ready



Professional
performance



New
construction
ideal

PLUG-IN

Three Prong motorization plugs into any standard outlet for instant operation. No permanent wiring, no electrician required.

Easy to install, relocate, or remove as needs change. Perfect for rental spaces, retrofits, or anywhere permanent wiring isn't practical.

Products

- Motorized Plug-in - 4" Cassette - [SS-RS-MOT-PL-CS4](#)
- Motorized Plug-in - 4" Fascia- [SS-RS-MOT-PL-FA4](#)
- Motorized Plug-in - Open Roll - [SS-RS-MOT-PL-OR](#)
- Motorized Plug-in - 3" Fascia - [SS-RS-MOT-PL-FA3](#)



Standard outlet
power



No electrician
needed for
wireless
controls



Relocatable



Quick setup



Lower costs

BATTERY

Battery motorization delivers wireless operation with rechargeable power. Install anywhere without electrical connections.

Rechargeable lithium battery provides months of operation between charges via simple USB charging. Ideal for spaces without power access or where wiring would be difficult or expensive.

Products

- Motorized Battery Powered - 4" Cassette - [SS-RS-MOT-BA-CS4](#)
- Motorized Battery Powered - 4" Fascia - [SS-RS-MOT-BA-FA4](#)
- Motorized Battery Powered - Open Roll - [SS-RS-MOT-BA-OR](#)
- Motorized Battery Powered - 3" Fascia - [SS-RS-MOT-BA-FA3](#)



Completely
wireless



USB
rechargeable



Extended
runtime



No electrician
needed



Lower costs

Battery motorized shades are compatible with **SENTRY SOLAR™** - pages 12-13

FABRICS

SENTRY VISTA™ LIGHT FILTERING FABRICS

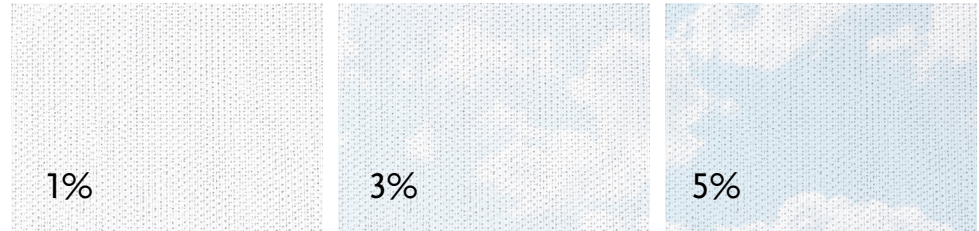

Sentry Vista™ Fabrics are engineered to control glare, reduce solar heat gain, and improve energy performance while maintaining natural daylight in interior spaces. An array of soft, neutral colour tones suits any commercial environment. Available in three openness factors — 1%, 3%, and 5% — with eight colours to suit any project.

With inherent flame retardant and anti-microbial properties, Sentry Vista™ Fabrics deliver complete light control and occupant comfort in every window. Maintain outward views while keeping interiors comfortable and protected.



B1
NFPA 701
CA TITLE 19
CAN/ULC-S109



ASTM G21
ASTM E2149

SENTRY VELOUR™ BLACKOUT FABRICS

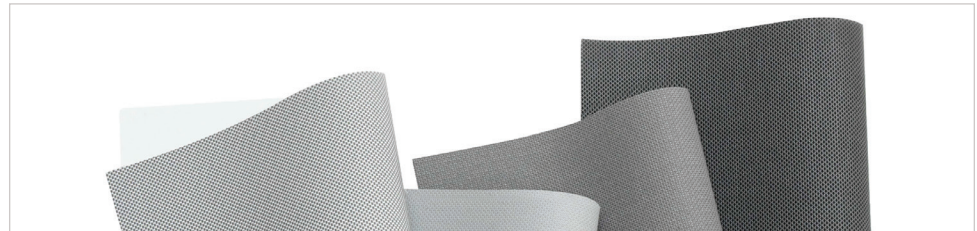

Sentry Velour™ PVC-free fabrics are engineered for complete blackout, delivering superior light control and total privacy. A clean look with a palette of soft colours suits any commercial space where performance and aesthetics both matter. Flame retardant certified for peace of mind without compromise.

Ideal for corporate boardrooms, executive offices, healthcare facilities, and any commercial space that demands reliable light control and a refined finish.



B1
NFPA 701
CA TITLE 19
CAN/ULC-S109

SENTRY NOIR™ BLACKOUT FABRICS

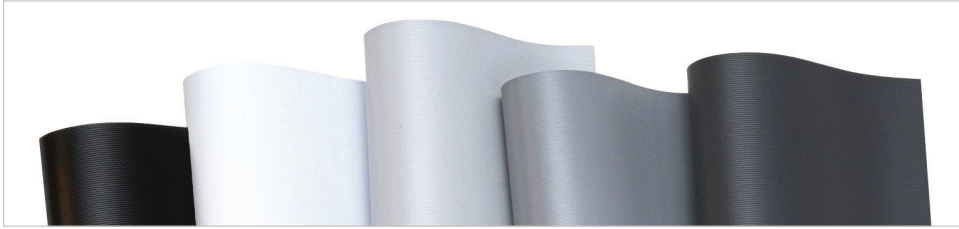

Sentry Noir™ Fabrics are engineered for complete blackout in high-use environments where durability and easy maintenance are critical. Smooth vinyl construction with flame retardant coating delivers practical performance that stands up to demanding applications. Complete light blocking with low-maintenance care.

With certified safety standards, Sentry Noir™ Fabrics provide reliable performance without compromise. Ideal for healthcare facilities, educational institutions, hospitality venues, and any commercial space requiring durable, hygienic light control with minimal upkeep.



FULL WRAP

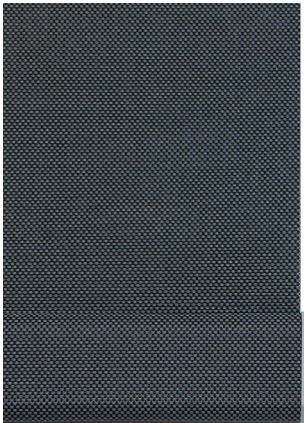

HALF WRAP

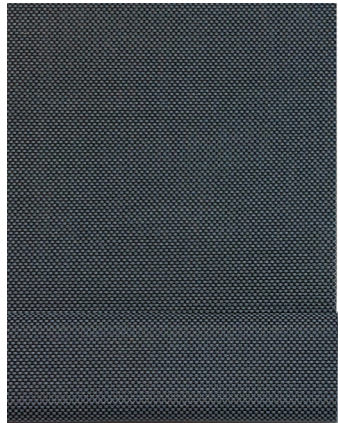

EXPOSED

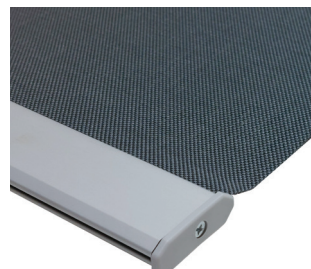
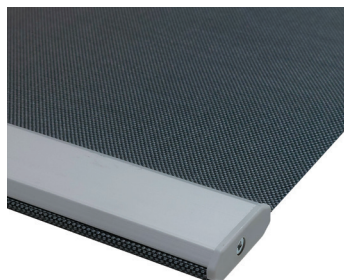
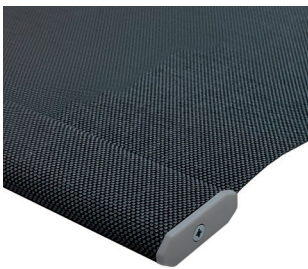
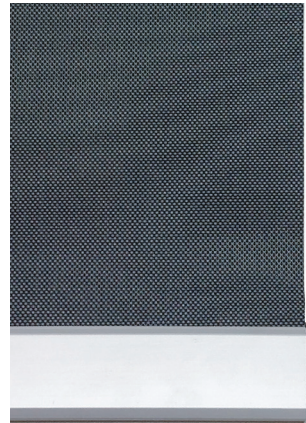

HEM BARS

COLOUR STUDIO

SENTRY VISTA™ 1%

SENTRY VISTA™ 3%

SENTRY VISTA™ 5%

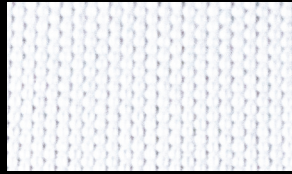

ICE WHITE E1-000

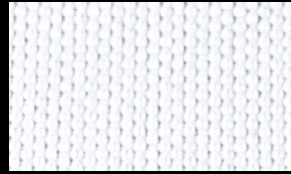

ICE WHITE E3-000



ICE WHITE E5-000

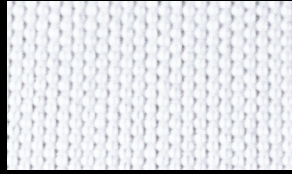

WHITE E1-001

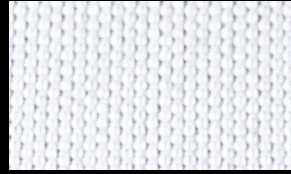

WHITE E3-001



WHITE E5-001

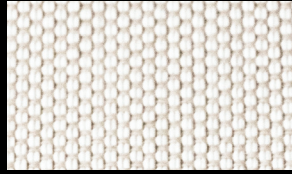

IVORY E1-002

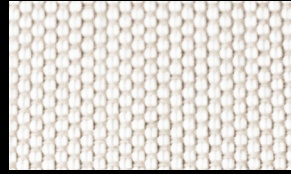

IVORY E3-002



IVORY E5-002

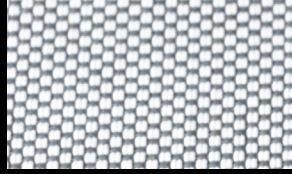

WHITE GREY E1-003

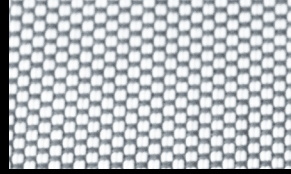

WHITE GREY E3-003

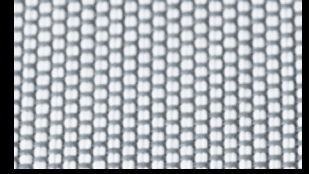

WHITE GREY E5-003

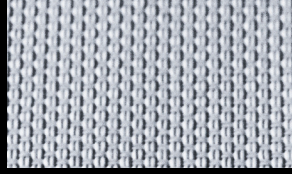

LIGHT GREY E1-005

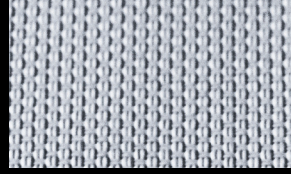

LIGHT GREY E3-005

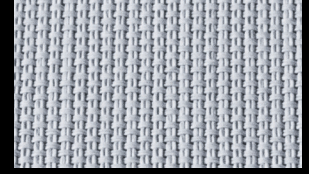

LIGHT GREY E5-005

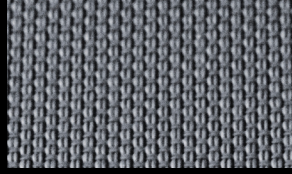

GREY E1-006

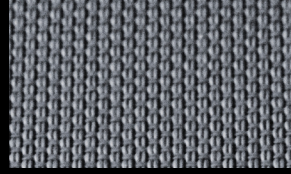

GREY E3-006

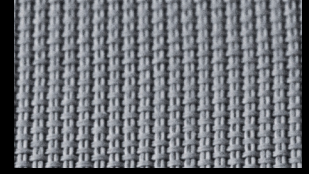

GREY E5-006

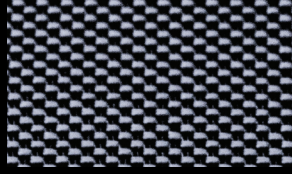

BLACK GREY E1-010

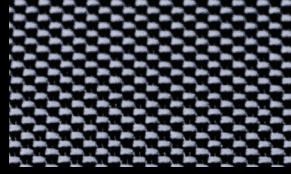

BLACK GREY E3-010



BLACK GREY E5-010



BLACK E1-011



BLACK E3-011

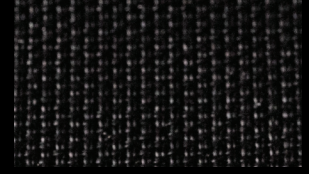

BLACK E5-011

SENTRY NOIR™

SENTRY VELOUR™

TOP TREATMENT

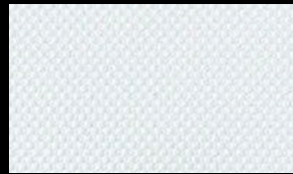

WHITE 43001



WHITE 134440



IVORY 43002



LIGHT GREY 134504



CHAMPAGNE 43010

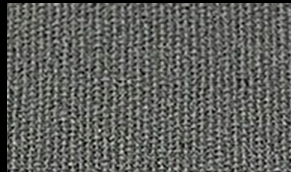

DARK GREY 134506



CREAM 43004



SOFT BEIGE 134513



LIGHT GREY 43003



SAND 134526

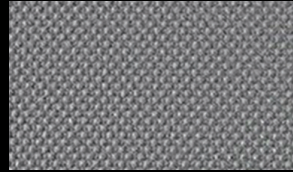

GREY 43006



COOL GREY 134537



BLACK 43008

In Stock Top Treatment Colours



ANODIZED

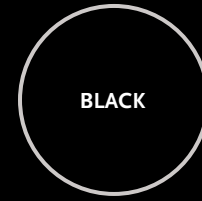

BLACK

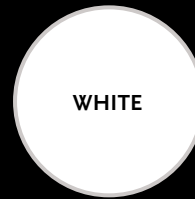

WHITE

Custom order Top Treatment Colours



BRONZE



ALABASTER

CHAIN COLOUR RANGE

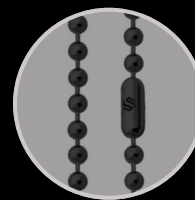

GUN METAL

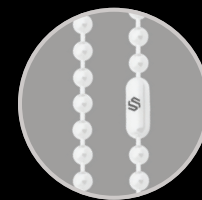

WHITE

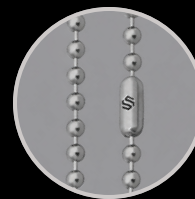

STAINLESS

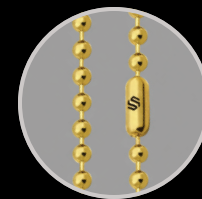

BRASS

CEILING POCKET

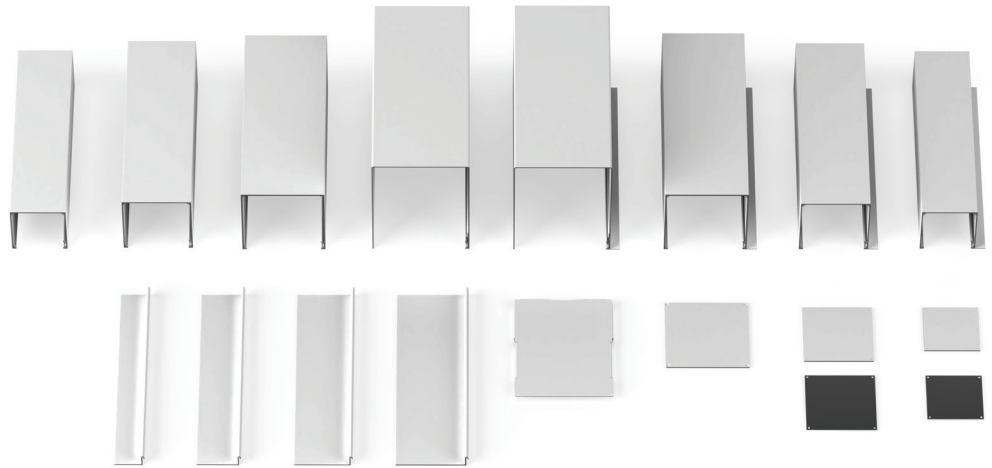

Ceiling Pocket Family

Retain design integrity with Sentry's complete window-to-wall recessed shade pocket systems. Designed to meet today's commercial project needs, our shade pocket systems are made with high-strength aluminum that is both workable and resistant to corrosion.

Constructed to work with Sentry motorized or manual shade systems, the simple pocket design can also be paired with other shading systems while still allowing shades to seamlessly disappear.



Domestically Stocked

Ships directly from our Canadian Warehouses.



Complete Size Range

Accommodate any size project with our complete range of ceiling pockets.



Complete the look

Rotationally symmetrical end plates and removable bottom closures available to complete the look.



Multi-functional

Works with single or dual, manual or motorized, roller or drapery shading systems.



10' Lengths

Shipped in 10' lengths to accommodate transport to and from job sites.



Field Adjustable

Make cuts on-site for a precise fit.



INNOVATION



HARNESS THE SUN WITH SENTRYSolar™

SentrySolar™ is a self-sustaining motorized shade system that eliminates electrical wiring. A compact solar panel sits behind the Top Treatment, completely out of sight, keeping the battery charged. It performs like a hard wired system without the complexity. No electrical work required, much easier installation, and lower costs. Ideal for retrofits, multi-unit projects, or anywhere electrical access is limited or cost prohibitive.

Products

- Motorized Solar Powered - 4" Cassette - [SS-RS-MOT-SP-CS4](#)
- Motorized Solar Powered - 4" Fascia - [SS-RS-MOT-SP-FA4](#)
- Motorized Solar Powered - Open Roll- [SS-RS-MOT-SP-OR](#)
- Motorized Solar Powered - 3" Fascia - [SS-RS-MOT-SP-FA3](#)

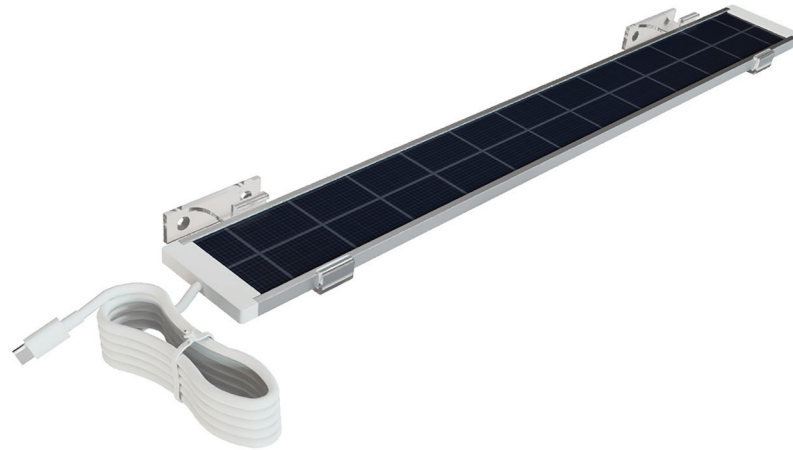

Zero operating cost
after installation.



Eliminates hardwiring
complexity and cost.



Sustainable by
design.



Perfect for retrofit
applications.



Whisper-quiet
motorized operation.

SENTRY SWIFTSET™ BRACKET SYSTEM

Sentry SwiftSet™ is an adjustable bracket system that solves the challenge of unlevel window frames. Quick vertical adjustment allows installers to level the shade tube within the Top Treatment, even when the frame isn't level. Ensures perfectly straight fabric rollout every time, preventing premature wear, fraying, and binding. No drywall rework, faster installation, and extended fabric life. Ideal for retrofit applications, older buildings, or any installation where frame irregularities are a concern.



**Compensates
for uneven
frames**



**Quick easy
leveling**



**Smooth
straight rollout**



**Extends
fabric life**



**Eliminates
drywall work**



Problem

Unlevel window frames and drywall create difficult shade installations and in some cases uneven fabric rollout causing premature wear, fraying, costly drywall rework, and unsatisfactory results.



Solution

Sentry SwiftSet™ adjustable bracket system makes it quick and easy for installers to level the shade tube within the valance, even when the frame isn't level, ensuring fabric rolls out perfectly straight and extends fabric life.





SENTRY DUOTONE™

Sentry DuoTone™ is a double-sided fabric system that delivers exterior consistency with interior customization. Woven from thin, lightweight vinyl coated polyester yarns in a unique twill weave, it creates distinct appearances on each side.

One color faces out for uniform building aesthetics, while a different color faces in to match interior design schemes. Maximizes outward visibility and solar heat reduction without compromise. Perfect for multi-unit buildings, corporate campuses, or any project where exterior uniformity and interior personalization both matter.



**Exterior
consistency**



**Interior
customization**



**Maximizes
outward
visibility**



**Superior solar
performance**



**Lightweight
design**



SENTRY PROSEAL™

Sentry ProSeal™ is a precision engineered brush strip that creates a seamless seal between the Top Treatment and drywall. Installed along the top edge of the Top Treatment, it eliminates light gaps and conceals imperfections for a clean, professional finish.

It delivers the performance of caulking without the permanence—maintaining full Top Treatment serviceability. No messy application, easier maintenance, and faster installation.

Ideal for new construction, retrofits, or any project where precision finishing matters.



**Professional
finish**



**Eliminates light
penetration**



**Faster
installation**



**Conceals
imperfections**



**Cost effective
finishing**

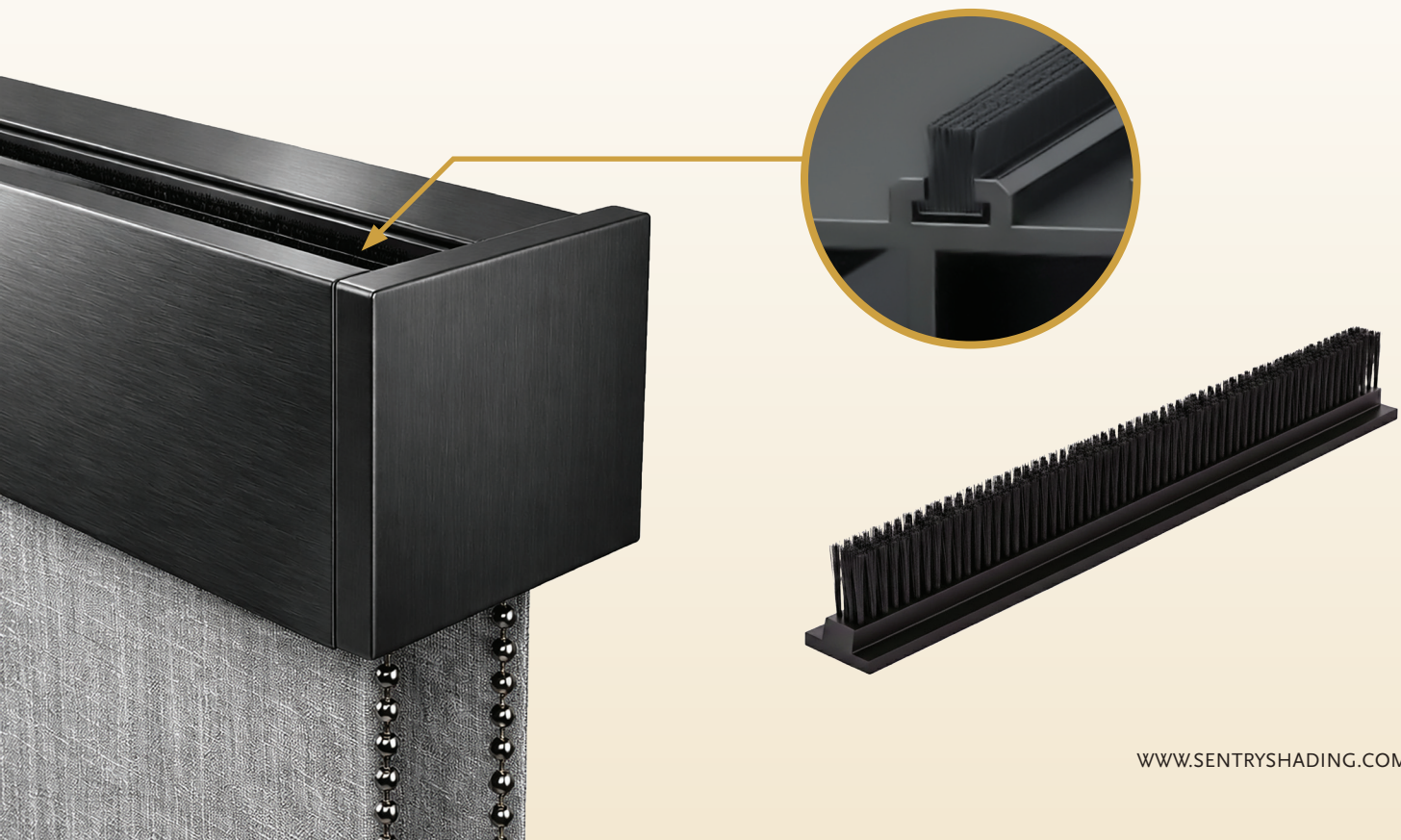



AVANA WESTERRA

SPECIFICATIONS

PROJECT

Project Name:	Avana Westerra
Product Name:	Manual Cordless - 4" Fascia
Product Number:	SS-RS-MAN-CL-FA4
Fabric Type:	Sentry Noir™ Blackout / Sentry Vista™ 3%
Fabric Colour:	White - 43001 / Ice White - E3-000
Hembar:	Half Wrap
Top Treatment Colour:	NA
Chain Colour:	NA

FEATURES:

SentrySolar™	
Sentry SwiftSet™	
SentryDuoTone™	
Sentry ProSeal™	



SPECIFICATIONS

PROJECT

Project Name:	StrideCare
Product Name:	Manual Chain Operated - 3" Fascia
Product Number:	SS-RS-MAN-CH-FA3
Fabric Type:	Sentry Vista™ 3%
Fabric Colour:	Black Grey - E3-010
Hembar:	Exposed
Top Treatment Colour:	Anodized
Chain Colour:	Stainless Steel

FEATURES:

SentrySolar™	
Sentry SwiftSet™	✓
SentryDuoTone™	
Sentry ProSeal™	✓





StrideCore

STRIDECARE

NW UROLOGY



SPECIFICATIONS

PROJECT

Project Name:	NW Urology
Product Name:	Manual Chain Operated - 3" Fascia
Product Number:	SS-RS-MAN-CH-FA3
Fabric Type:	Sentry Vista™ 5%
Fabric Colour:	Ivory - E5-002
Hembar:	Exposed
Top Treatment Colour:	Anodized
Chain Colour:	Stainless Steel

FEATURES:

SentrySolar™	
Sentry SwiftSet™	✓
SentryDuoTone™	
Sentry ProSeal™	



SPECIFICATIONS

PROJECT

Project Name:	Fresh Tracks
Product Name:	Manual Chain Operated - 3" Fascia
Product Number:	SS-RS-MAN-CH-FA3
Fabric Type:	Sentry Vista™ 3%
Fabric Colour:	White - E3-001
Hembar:	Half Wrap
Top Treatment Colour:	White
Chain Colour:	Stainless Steel

FEATURES:

SentrySolar™	✓
Sentry SwiftSet™	✓
SentryDuoTone™	
Sentry ProSeal™	✓

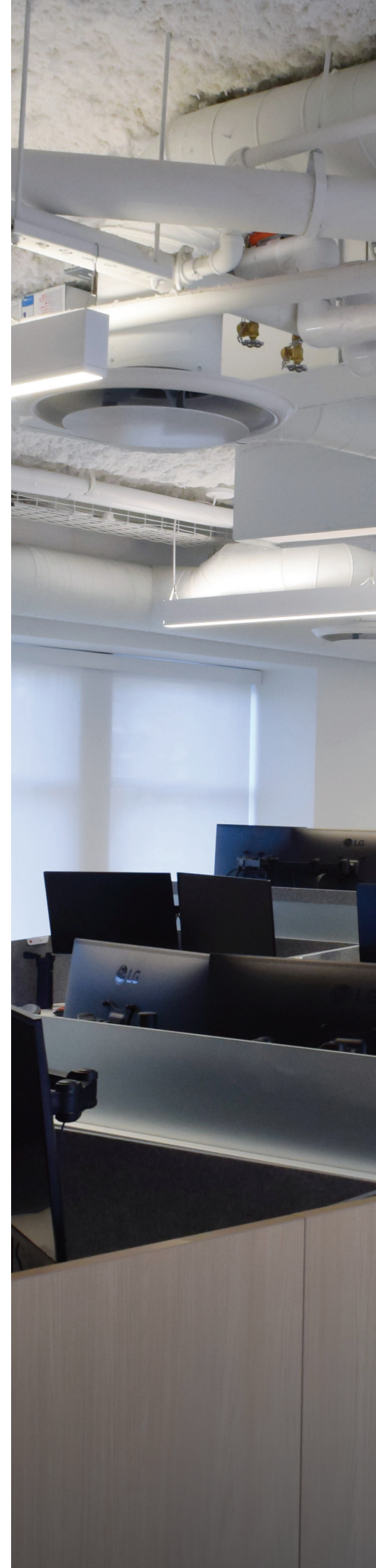



FRESH TRACKS

SOUTHPORT AEROSPACE CENTRE



SPECIFICATIONS

PROJECT

Project Name:	Southport Aerospace Centre
Product Name:	Manual Chain Operated - 3" Fascia
Product Number:	SS-RS-MAN-CH-FA3
Fabric Type:	Sentry Noir™ (Blackout)
Fabric Colour:	Grey - 43006
Hembar:	Full Wrap
Top Treatment Colour:	Anodized
Chain Colour:	Stainless Steel

FEATURES:

SentrySolar™	
Sentry SwiftSet™	✓
SentryDuoTone™	
Sentry ProSeal™	

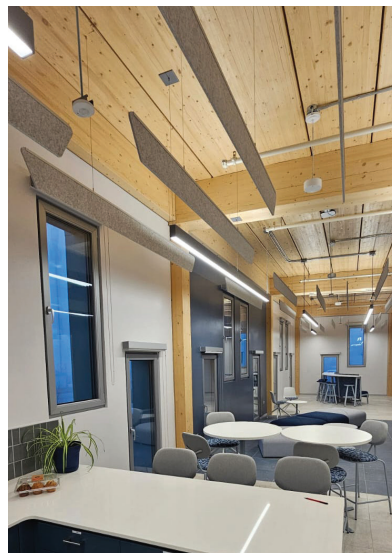

SPECIFICATIONS

PROJECT

Project Name:	South Broad Plaza
Product Name:	Manual Chain Operated - Open Roll
Product Number:	SS-RS-MAN-CH-OR
Fabric Type:	Sentry Vista™ 3%
Fabric Colour:	Ivory - E3-002
Hembar:	Exposed
Top Treatment Colour:	White
Chain Colour:	Stainless Steel

FEATURES:

SentrySolar™	
Sentry SwiftSet™	✓
SentryDuoTone™	
Sentry ProSeal™	



SOUTH BROAD PLAZA





ARCHITECT

RESOURCES

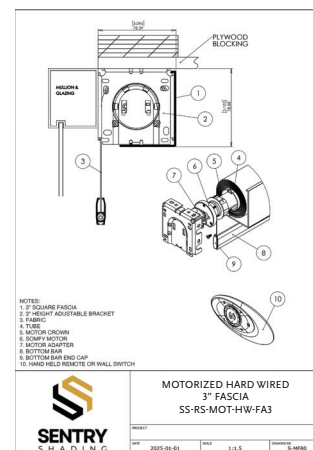
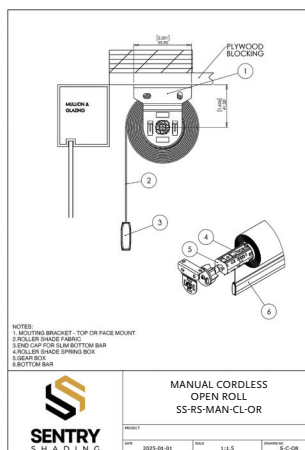
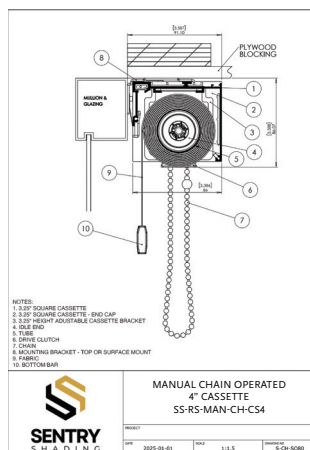

Explore our complete library of technical documentation for all Sentry Shades. Find detailed shop drawings and written specifications to support your work.

Our goal is to make it easy to locate the information you need.

All resources are available digitally for quick reference and download. Scan the QR code or visit the URL below to visit our Architect Resources webpage.

Download Shop Drawings
SCAN QR CODE

or visit
sentryshading.com/products



Expertly Crafted
Shading Solutions.



+1 877-920-4211
info@sentryshading.com
www.sentryshading.com



PROUDLY
MANUFACTURED
IN CANADA

EDITION #01